



# SGCWE100/865

## WIRELESS CONVENTIONAL SYSTEM EXPANDER MODULE

### GENERAL DESCRIPTION

The wireless conventional system expander module is a device permitting to add a wireless sub-system to a conventional fire security installation. This device is connected directly to the conventional control panel's zone line and is actually part of it. This device allows wireless sounders silencing by being controlled by the control panel's sounder output line.

**Note: The latest release of the wireless system configuration software is available from the manufacturer's website.**

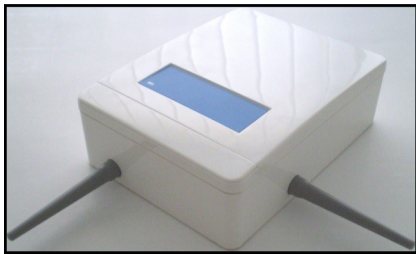

Picture 1 - Device overview

### WHAT TO CHECK BEFORE INSTALLATION

Before installing the conventional system expander module check these following items:

- This device must be installed following your national and / or international codes of practice and standards; check them before performing the installation of this device.

- This device is compatible with most of the conventional control panels; check that the control panel is equipped with a power supply output through which you can, if desired, power the conventional system expander module; check if the panel is provided with a sounder output; check that control panel's specifications are suitable; for all this, consult your control panel's documentation or consult your control panel's supplier for more information.

### DEVICE POSITIONING FOR RADIO COMMUNICATION PERFORMANCE AND STABILITY

The conventional expander module must have a good radio communication with its wireless system's child devices. In order to achieve this, before positioning it and installing it, apply scrupulously the following points:

- Avoid installing the module close to:
  - equipment using large amounts of electrical current
  - large metal objects, structures or metal ceiling structures
  - fluorescent lighting fixings
  - computers, their cabling and network cabling.
- If there are other wireless translators or wireless modules, keep a distance between them of at least 2 meters. In general every installed radio device (child devices included) must have a minimum distance of at least 2 meters from each other.
- It is recommended to install the conventional expander at a height from the floor of at least 2 - 2.5 meters.
- Install the conventional expander perfectly flat on the wall.
- The conventional expander must be installed perfectly straight on the wall; this means that the antenna under the device must be perpendicular to the floor and the antenna on the right of the device must be parallel to the floor.
- Environmental parameters (temperature, humidity and so on) must be in the ranges specified in the conventional expander's technical specifications, which can be found at the beginning of this manual; this point applies, obviously, to all other wireless devices.
- After having installed the conventional expander, make sure that its child devices (sensors, call points, etc.) are reached by a good, strong signal (refer to the single device's manuals) in their position of installation. Radio transmission ranges for the conventional expander can be found in the technical specifications at the beginning of this manual.
- Use the personal computer's "Wirelex-fire" software for configuring and administering the system.

### PLACEMENT AND FIXING

The conventional system expander module's lodgement box is designed with four 20 mm breakable, "knock-out" entry holes (two at the top and two on the upper side of the rear of the box), allowing sealed, cable gland fitted, cables to be connected to the device. To place and fix the module perform in sequence the following steps:

- Find a suitable location for the device's box.
- Prepare the cable openings on the box.
- Securely and adequately fix the device's box to the wall with adequate screws.
- Fit the cable's gland (or glands) into the "knocked out" device box's cable entry; check gland's IP rating: it must be equal or greater than the IP rating of the expander module; see the TECHNICAL SPECIFICATIONS table.
- Feed the cables into the box, giving them sufficient length for a secure connection.

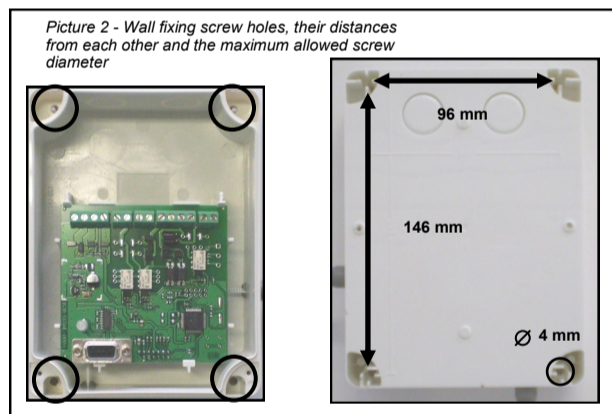

Picture 2 - Wall fixing screw holes, their distances from each other and the maximum allowed screw diameter

Picture 3 - Breakable holes for cable entry

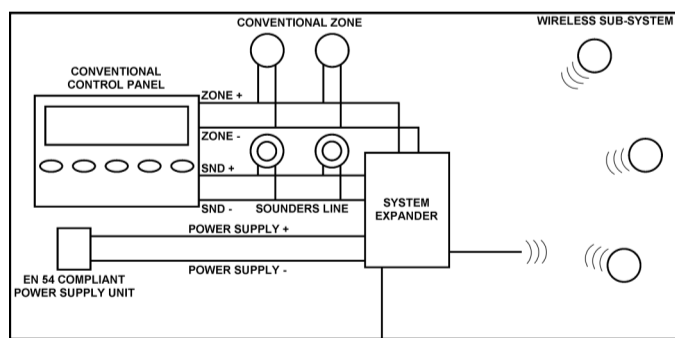

Picture 4 - An example of a conventional - wireless system

### WIRING CONNECTIONS

The conventional system expander module's wiring phase of the installation has the following objectives:

- Connect the power supply cables (either from the control panel or from an independent source).
- Connect main and backup power supply monitoring inputs (optional).
- Connect the conventional zone line.
- Connect the control panel's sounder output (optional).
- Install the end of line (EOL) resistors required as specified in this manual; their values must be chosen according to the control panel's specification and literature.

### WIRING WARNINGS

Three warnings about wiring:

- Perform any wiring operation with the power supply source and the control panel inactive.
- Electrostatic sensitive device: observe precautions when handling and making connections.
- Connections to the terminals are polarity sensitive, thus, please, check them by referring to the wiring instructions of this manual.

### IMPORTANT NOTE

Check and apply the "ZONE ALARM EOL" and the "CHECKING THE POSITIONING OF THE ELECTRICAL BRIDGES" paragraphs before using the expander module.

### DEVICE WIRING - POWER SUPPLY

The conventional system expander module must be power supplied either:

- directly by the control panel or
- from an external power source or
- from an external power source with a power backup unit.

Use the scheme at the right for connecting the power supply to the device.

This terminal wiring scheme is always applied.

If you want to use an external power source with a power backup unit, two additional module's terminal blocks come in use: "MAIN MONITORING" and "BACKUP MONITORING".

"MAIN MONITORING" is a terminal that supervises the main power supply of an external power supply unit.

"BACKUP MONITORING" is a terminal that supervises the backup power supply of an external power supply unit.

Let's have two examples of power supply units:

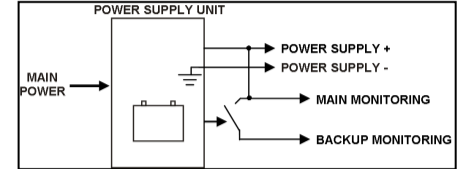
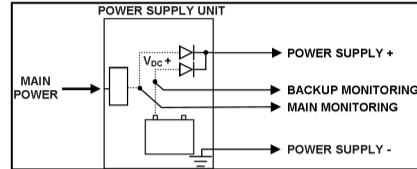

Picture 6 & 7 - Power supply unit example schemes

"MAIN MONITORING" and "BACKUP MONITORING" lines will be connected to the module as in the following scheme:

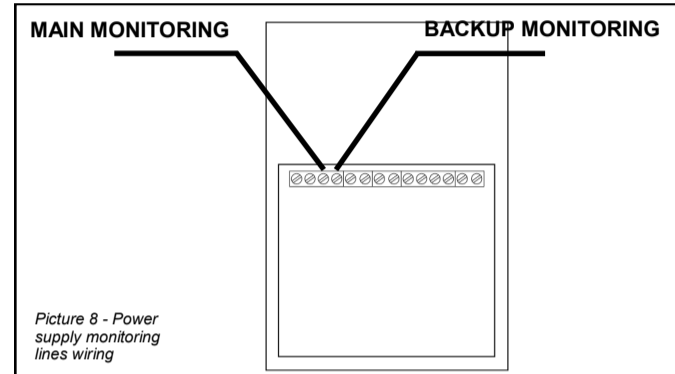

Picture 8 - Power supply monitoring lines wiring

### WARNING!

"POWER SUPPLY -" AND "POWER SUPPLY +" WIRES MUST PASS INTO THE SUPPLIED FERRITE RING.

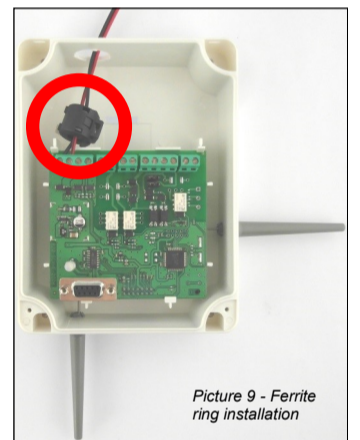

Picture 9 - Ferrite ring installation

### DEVICE WIRING - CONVENTIONAL ZONE LINE

In order to connect this device to the conventional zone line, two types of schemes can be used, depending on the positioning of the expander module on the line:

- the expander module is positioned at the beginning or in the middle of the zone line (conventional devices follow the device on the line or are positioned before and after it); therefore the zone line EOL resistor must be fitted externally as is normally done, but not into the device's terminal blocks:

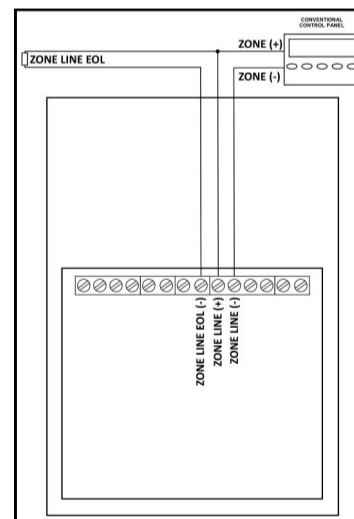

Picture 10 - Conventional line wiring (zone line EOL resistor outside of the device)

**IMPORTANT:** Please note that with this wiring arrangement, if a fault occurs on the wireless sub-system, the remaining conventional zone after the expander may be isolated until the fault has been cleared. This will apply unless each detector on the circuit is equipped with a Schottky diode that the panel can use for continuity purposes.

Please refer to your applicable codes of practice and to your conventional control panel documentation.

- the expander module is positioned at the end of the zone line (all conventional devices are positioned before it); therefore the zone line EOL resistor must be fitted to the device's terminals and not externally as normally is done.

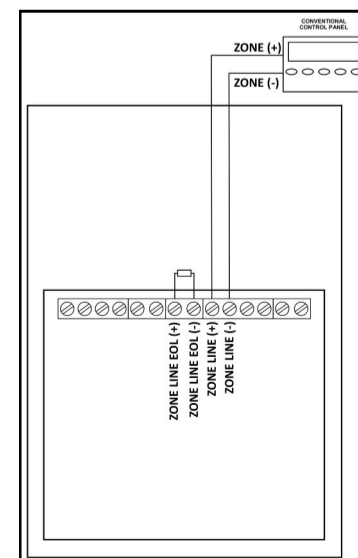

Picture 11 - Conventional line wiring (zone line EOL resistor inside of the device)

**DEVICE WIRING - CONTROL PANEL SOUNDER OUTPUT LINE**

Conventional sounders are installed on the sounders line and the voltage level applied to their terminals by the control panel controls their functioning by activating or deactivating them (silencing).  
 Wireless sounders are controlled in the same exact way through the wireless expander module; this means that this kind of radio outputs respond indirectly to the voltage level applied by the control panel to the sounders line positive and negative terminals of the expander module.  
 In order to connect the module to the sounders line, two types of schemes can be used, depending on the positioning of the expander module on this line:

- the expander module is positioned at the beginning or in the middle of the sounders line (sounder devices follow the module on the line or are positioned before and after it); therefore the sounders line EOL resistor must be fitted externally as is normally done, but not into the device's terminal blocks:

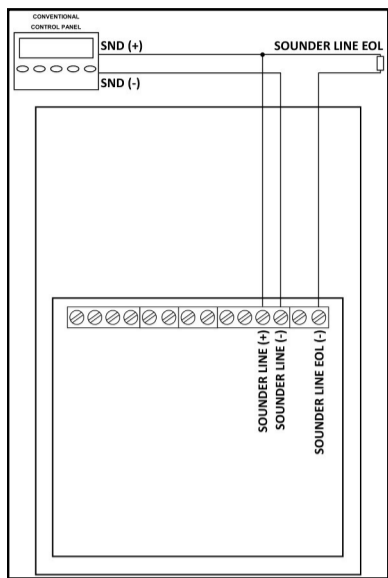

Picture 12 - Sounders line wiring (sounders line EOL resistor outside of the device)

**IMPORTANT:** Please note that with this wiring arrangement, if a fault occurs on the wireless sub-system, the remaining sounders line after the expander may be isolated until the fault has been cleared. This will apply unless each sounder on the sounders line is equipped with a Schottky diode that the panel can use for continuity purposes.  
 Please refer to your applicable codes of practice and to your conventional control panel documentation.

- the expander module is positioned at the end of the sounders line (all sounders are positioned before it); therefore the sounders line EOL resistor must be fitted to the device's terminals and not externally as normally is done.

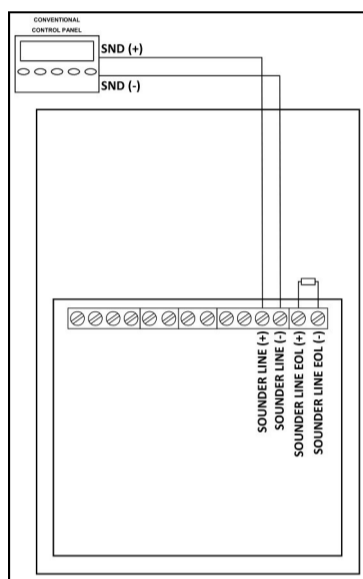

Picture 13 - Sounders line wiring (sounders line EOL resistor inside of the device)

**ZONE ALARM EOL**

The zone alarm end of line (EOL) resistor must ALWAYS be installed on the expander; to have its value refer to your control panel's literature.

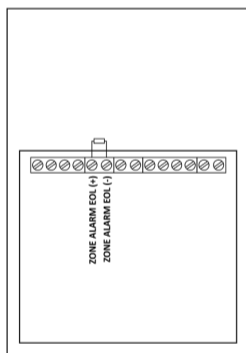

Picture 14 - Zone alarm EOL installation terminal blocks on the expander device

**CHECKING THE POSITIONING OF THE ELECTRICAL BRIDGES**

In order to function, the wireless expander module needs to have two electrical bridges fitted on the pins on its PCB in the way illustrated in the following picture:

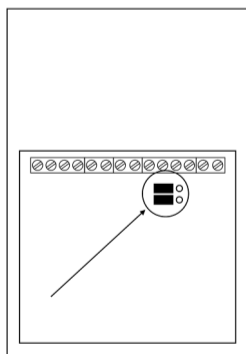

Picture 15 - Electrical bridges correct positioning

**VISUAL LED INDICATOR**

The conventional expander module is equipped with a three-colour LED (red, green and amber) that provides visual indication for power supply conditions; this indicator is positioned on the internal PCB of the device and it's light is visible through a slit on the device's cover.

The table 1 illustrates the possible LED visual signals and their meaning.

Device Status	Green LED	Red LED
Normal	Continuous glowing	-
Primary power supply fault	-	Continuous glowing
Backup power supply fault	Sequential green - red blinks	

Table 1

**PROGRAMMING THE WIRELESS SUB-SYSTEM**

The wireless sub-system is created and programmed through the use of a "Wireless Fire" program installed on a personal computer that is connected via RS232 serial port to the wireless conventional system expander module.

**TESTING THE WIRELESS CONVENTIONAL SYSTEM EXPANDER MODULE**

Testing needs the fire security system to be wired, programmed and armed.

Trigger an alarm on the wireless sub-system: as a consequence the conventional control panel must set into alarm.

After the test reset the whole system from the control panel.

**SEALING THE DEVICE WITH ITS COVER**

After testing you can install the device's cover onto the module and, safely and securely, close it by using the screws provided.

**WARNINGS AND LIMITATIONS**

Our devices use high quality electronic components and plastic materials that are highly resistant to environmental deterioration. However, after 10 years of continuous operation, it is advisable to replace the devices in order to minimize the risk of reduced performance caused by external factors. Ensure that this device is only used with compatible control panels. Detection systems must be checked, serviced and maintained on a regular basis to confirm correct operation.

Smoke sensors may respond differently to various kinds of smoke particles, thus application advice should be sought for special risks. Sensors cannot respond correctly if barriers exist between them and the fire location and may be affected by special environmental conditions.

Refer to and follow national codes of practice and other internationally recognized fire engineering standards. Appropriate risk assessment should be carried out initially to determine correct design criteria and updated periodically.

**WARRANTY**

All devices are supplied with the benefit of a limited 3 years warranty relating to faulty materials or manufacturing defects, effective from the production date indicated on each product. This warranty is invalidated by mechanical or electrical damage caused in the field by incorrect handling or usage. Product must be returned via your authorized supplier for repair or replacement together with full information on any problem identified.

Full details on our warranty and product return policy can be obtained upon request.



ARGUS SECURITY S.R.L.  
 Via del Canneto, 14  
 34015 Muggia (TS)  
 Italy  
 19

EN 54-25:2008  
 EN 54-18:2005  
 SGCWE100/865

For use in compatible fire detection and alarm system