

COMPATIBILITY

This acoustic device is only compatible with conventional control panels and systems, unless an approved optional module is fitted. For more specific information regarding compatibility refer to your fire security system supplier and the technical documentation concerning the control panel in use.

INSTALLATION - IMPORTANT NOTES

Refer to national and international standards in use for spacing and positioning of the fire security's system devices; refer also to specific standards and your supplier if the system is going to be installed in particular environments or environments where specific risks exist.

This device is to be used only with conventional control panels and systems (check the COMPATIBILITY paragraph).

This device must be wired according to the connection details described in this manual.

Disconnect the sounder line from the control panel before installing this device.

Test the device after installation.

SOUNDER OPENING PROCEDURE

In order to detach the upper sounder body from the base:

- 1) Insert the pins of the compatible key into the holes of one of the two side locking mechanisms.
- 2) Turn the key 90° to the left whilst applying light pressure.
- 3) Repeat this step for the second side locking mechanism; the locking mechanism appears as in picture 1 when in the open position (flush).
- 4) Detach the sounder body from the base by pulling gently to separate (picture 3).

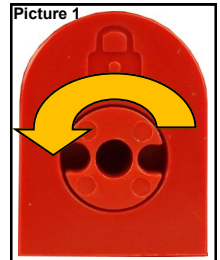

SOUNDER CLOSING PROCEDURE

In order to assemble the sounder body to the base:

- 1) Assemble the sounder body to the base using gentle pressure (picture 3).
- 2) Insert the pins of the compatible key into the holes of one of the two side locking mechanisms.
- 3) Turn the key 90° to the right.
- 4) Repeat this step for the second side locking mechanism, starting from point 2; the locking mechanism appears as in picture 2 once closed (recessed).
- 5) To secure use the retaining screws, using the location holes on both sides of the base (picture 4).

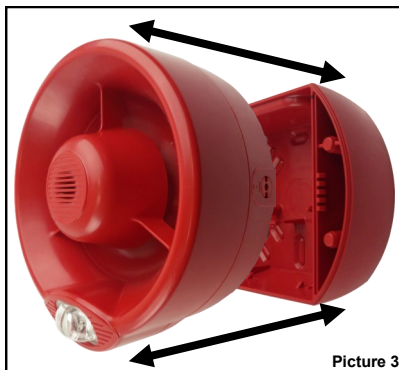
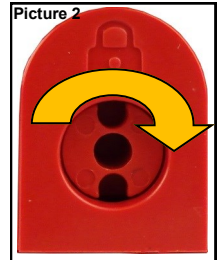

Picture 3



Picture 4



EN 54-3 Type B - approved for outdoor use.

OUTDOORS AND DAMP ENVIRONMENTS INSTALLATION

When installing the sounder outdoors or in a damp environment, carefully apply the self-adhesive sealing pad to the back of the sounder base (picture 5).

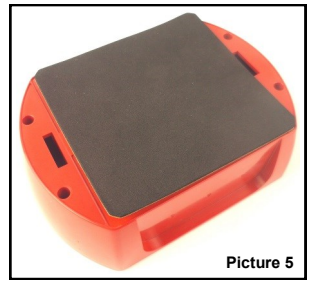

Picture 5

WALL INSTALLATION

- 1) Choose the installation location for the sounder based upon system design regulations.
- 2) Fix the sounder base to the wall; the prepared location options for the fixing screws are highlighted in picture 6.

CABLE ENTRIES

The sounder base is provided with a knockout entry for the system cables, located in the centre of the base (picture 7).

The side wall of the base has prepared drilling points to allow for installation of cable glands; a row of three drilling points are provided to allow for single or twin cable connection (picture 8).

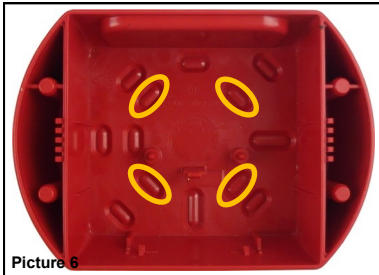

Picture 6

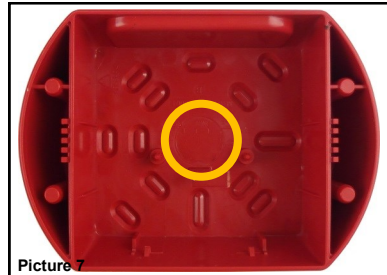

Picture 7



Picture 8

TERMINAL BLOCKS INSTALLATION

The terminal block on the back of the sounder body is installed as illustrated in picture 9.

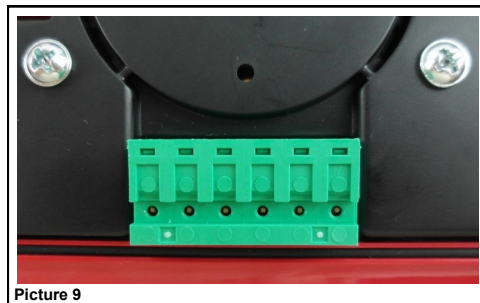

Picture 9

WIRING

Connect the sounder to the sounder circuit from the control panel; wiring terminal connections are as illustrated in picture 10 and described in table 1; an example of a typical circuit wiring arrangement is shown in picture 11.

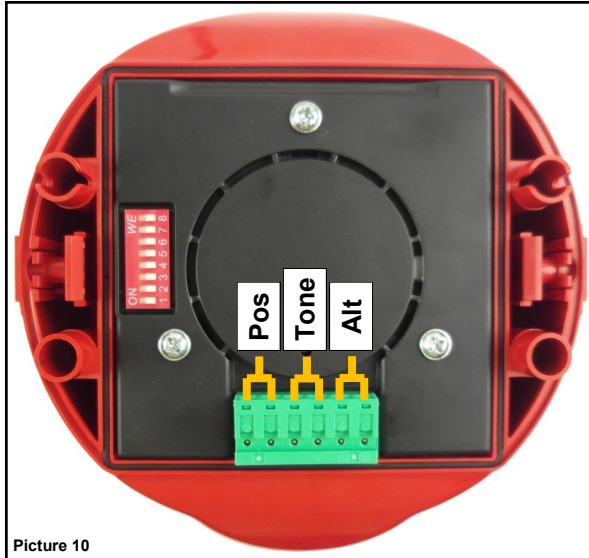

Picture 10

Terminal block number	Terminal block designation	Notes	Usage
1	Pos	Terminal blocks for the line's positive terminals (+). These block are shorted: either one can be used.	Connect to the positive terminals of the control panel's sounder circuit.
2			
3	Tone	Terminal blocks for the line's negative terminals (-). These block are shorted: either one can be used.	Connect to the negative terminals of the control panel's sounder circuit. Wiring to these terminal blocks acti-
4			
5	Alt	Terminal blocks for the line's negative terminals (-). These block are shorted: either one can be used.	Connect to the negative terminals of the control panel's sounder circuit. Wiring to these terminal blocks activates the alternate tone set.
6			

Table 1

! Use of the Tone or Alt terminals enable, respectively, the main tone set or the alternate one; refer to the MAIN TONE SET and the ALTERNATE TONE SET paragraphs.

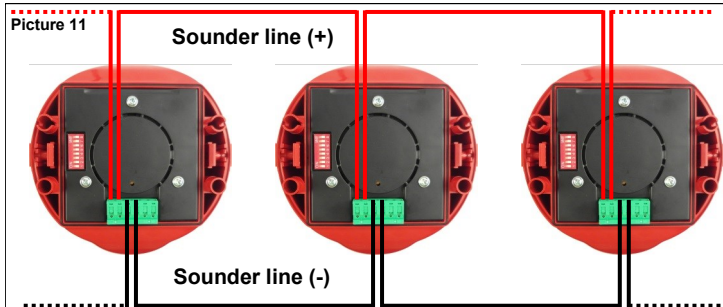

! The sounder line must be capable of providing a surge/power-up current of at least 2 times the sum of the indicated current of all the AV devices on the line itself.

The sounder line must be capable of providing a steady state current of at least 1.5 times the sum of the alarm currents of all the AV devices on the line itself.

OUTPUT TONE SETTING

Use the DIP switch on the back of the sounder body to select the tone required; for this function the first five switches are used, highlighted in picture 12.

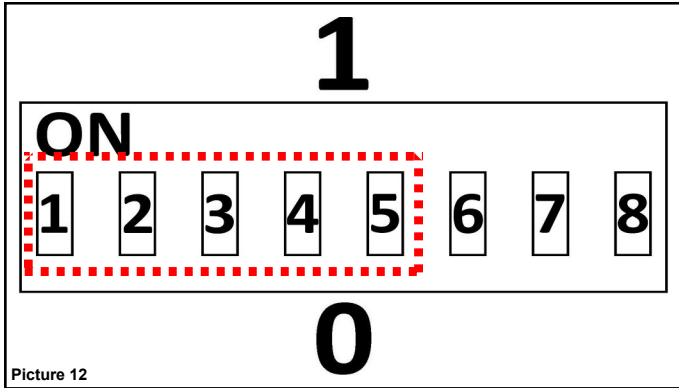

Picture 12

The switches positioned upwards acquire value "1"; on the other hand, if positioned downwards acquire value "0".

- 1) From the MAIN TONE SET table or the ALTERNATE TONE SET table (the choice of the table depends on how the sounder's wiring has been carried out) select the output alarm tone triggered when the sounder is activated.
- 2) Refer to the corresponding line of the "DIP configuration" column to select the five switch selection settings.

OUTPUT VOLUME SETTING

Use the DIP switch at the back of the sounder body to select the output volume; in particular, switches 6 and 7, highlighted in picture 13, are used.

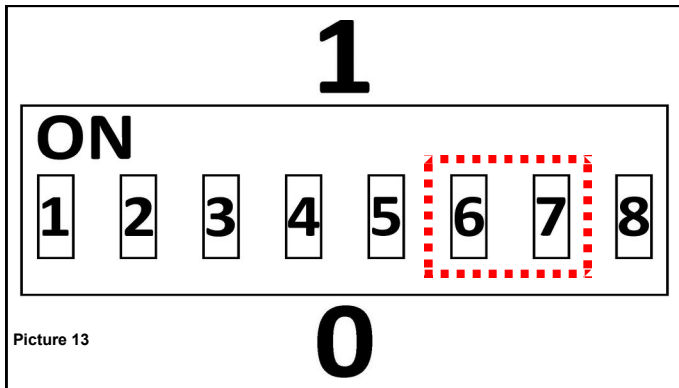

Picture 13

The switches positioned upwards acquire value "1"; on the other hand, if positioned downwards acquire value "0".

- 1) Select the alarm volume required when the sounder is activated (table 2).
- 2) Refer to the corresponding line of the "DIP configuration" column to set the two volume selection switches.

Tone volume	DIP configuration - switch 6 and 7	dB(A) evaluation	Notes
HIGH	11	100 dB(A) +/- 3	All tones
MEDIUM HIGH	01		
MEDIUM LOW	10		
LOW	00		

Table 2

MAIN TONE SET

Tone number	Tone designation	Tone description	DIP switch configuration: 1,2,3,4 e 5
1 *	Warble Tone	800Hz for 500ms, then 1000Hz for 500ms	11101
2 *	Continuous tone	970Hz continuous tone	01011
3 *	Slow Whoop (Dutch)	500-1200Hz for 3500ms, then off for 500ms	10101
4 *	German DIN tone	1200-500Hz swept every 1000ms (1Hz)	00111
5	Alternate HF slow sweep	2350-2900Hz swept every 333ms (3Hz)	10010
6	Alternative warble	800Hz for 250ms, then 960Hz for 250ms	11110
7	Alternative warble	500Hz for 250ms, then 600Hz for 250ms	11100
8	Analogue sweep tone	500-600Hz swept every 500ms (2Hz)	10100
9	Australian Alert (intermittent tone)	970Hz for 625ms, then OFF for 625ms	10001
10	Australian Evac (slow whoop)	500-1200Hz sweep for 3750ms, then OFF for 250ms	10110
11	Alternative warble	990Hz for 250ms, then 665Hz for 250ms	00001
12	French tone AFNOR	554Hz for 100ms, then 440Hz for 400ms	00101
13	HF Back up interrupted tone	2800Hz for 1s, then OFF for 1s	11011
14	HF Back up interrupted tone – fast	2800Hz for 150ms, then OFF for 150ms	11001
15	HF Continuous	2800Hz continuous	01001
16	Interrupted tone	800Hz for 500ms, then OFF for 500ms	01111
17	Interrupted tone medium	1000Hz for 250ms, then OFF for 250ms	01101
18	ISO 8201 LF BS5839 Pt 1 1988	970Hz for 500ms, then OFF for 500ms	01110
19	ISO 8201 HF	2850Hz for 500ms, then OFF for 500ms	01100
20	LF Back up Alarm	800Hz for 150ms, then OFF for 150ms	11010
21	LF Buzz	800-950Hz swept every 9ms	01010
22	LF Continuous tone BS5839	800Hz continuous	11000
23	Silent	No sound	11111
24	Siren 2 way ramp (long)	500-1200Hz rising for 3000ms, then falling for 3000ms	00000
25	Siren 2 way ramp (short)	500-1200Hz rising for 250ms, then falling for 250ms	00010
26	Swedish all clear signal	660Hz continuous	00100
27	Swedish Fire signal	660Hz for 150ms, then OFF for 150ms	00110
28	Sweep tone (1 Hz)	800-900Hz swept every 1000ms	10111
29	Sweep tone (3 Hz)	800-970Hz swept every 333ms (3Hz)	10011
30	Sweep tone (9 Hz)	800-970Hz swept every 111ms (9Hz)	01000
31	US Temporal Pattern HF	(2900Hz for 500ms ON, 500ms OFF) x3, then 1500ms OFF	00011
32	LF Sweep (Cranford tone)	800-1000Hz swept every 500ms (2Hz)	10000

* EN 54-3 certified tones

Table 3

ALTERNATIVE TONE SET

Tone number	Tone description	DIP switch configuration: 1,2,3,4 e 5
1	800Hz continuous	11101
2	1000Hz continuous tone	01011
3	500-1200Hz for 3500ms, then off for 500ms	10101
4	800Hz continuous	00111
5	2400Hz continuous	10010
6	800Hz continuous	11110
7	500Hz continuous	11100
8	500Hz continuous	10100
9	2400Hz continuous	10001
10	500-1200Hz sweep for 3750ms, then OFF for 250ms	10110
11	990Hz continuous	00001
12	800Hz continuous	00101
13	2800Hz continuous	11011
14	800Hz continuous	11001
15	2800Hz continuous	01001
16	800Hz continuous	01111
17	800Hz continuous	01101
18	970Hz for 500ms, then OFF for 500ms	01110
19	2850Hz for 500ms, then OFF for 500ms	01100
20	800Hz continuous	11010
21	800Hz continuous	01010
22	800Hz continuous	11000
23	970Hz continuous	11111
24	800Hz continuous	00000
25	800Hz continuous	00010
26	660Hz continuous	00100
27	660Hz for 150ms, then OFF for 150ms	00110
28	800Hz continuous	10111
29	800Hz continuous	10011
30	800Hz continuous	01000
31	2900Hz continuous	00011
32	800Hz continuous	10000

Table 4

TESTING

- 1) Activate an alarm or evacuate condition at the control panel.
- 2) Check both the audible and visual activation of the sounder/VAD.
- 3) Press the SILENCE SOUNDERS button (or equivalent) and ensure all Sounder type devices have silenced before continuing.
- 4) Reset the system from the control panel.

All devices must be tested after installation and thereafter on a periodic basis as required by local codes.

TECHNICAL SPECIFICATIONS *	
Power supply voltage range	15 - 40 Vdc (24 Vdc standard value)
Activated current load range, volume set to HIGH. Valid for all tones	11 - 25 mA at 24 Vdc
Acoustic emission frequency range. Valid for all tones	440 - 2900 Hz
Maximum acoustic intensity, volume set to HIGH. Valid for all tones	100 dB(A) \pm 3
Visual Alarm Device (VAD) frequency	0.5 Hz
VAD flash coverage	W - 2.5 - 7 (122.5 m ³)
Tolerated temperature range	-25 °C / +70 °C
Maximum tolerated humidity	95% RH (without condensation)
Height (base included)	92 mm
Diameter	130 mm
Weight (base included)	290 g
IP rating (EN 54-3 certified)	33
IP rating (not certified) **	65

* Consult the latest version of the TDS-CWSXX document for further information, obtainable from your supplier.

** Independently assessed and certified to IPX5 (not part of the current EN54-3 certification).

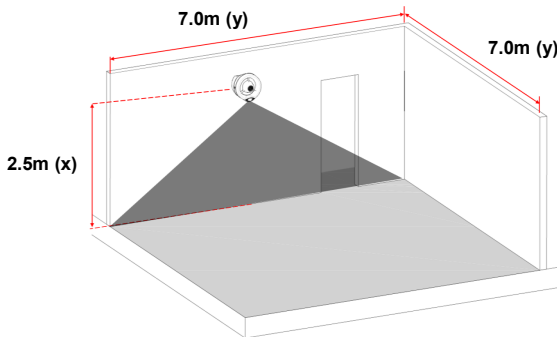

Wall mounted device demonstration

ACOUSTIC OPERATIONAL PERFORMANCE

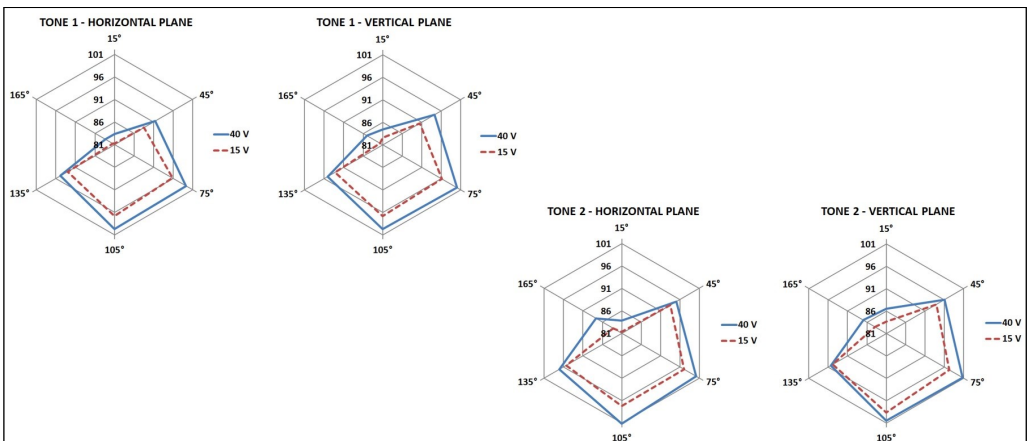

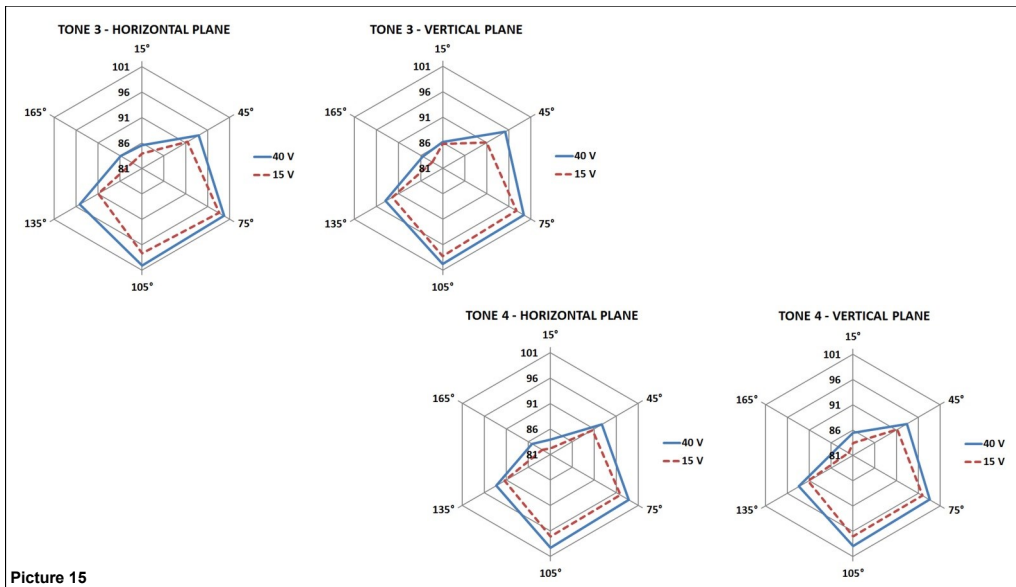

Picture 15

WARNINGS AND LIMITATIONS

Our devices use high quality electronic components and plastic materials that are highly resistant to environmental deterioration. However, after 10 years of continuous operation, it is advisable to replace the devices in order to minimize the risk of reduced performance caused by external factors. Ensure that this device is only used with compatible control panels. Detection systems must be checked, serviced and maintained on a regular basis to confirm correct operation.

Smoke detectors may respond differently to various kinds of smoke particles, thus application advice should be sought for special risks. Detectors cannot respond correctly if barriers exist between them and the fire location and may be affected by special environmental conditions.

Refer to and follow national codes of practice and other internationally recognized fire engineering standards.

Appropriate risk assessment should be carried out initially to determine correct design criteria and updated periodically.

WARRANTY

All devices are supplied with the benefit of a limited 5 years warranty relating to faulty materials or manufacturing defects, effective from the production date indicated on each product.

This warranty is invalidated by mechanical or electrical damage caused in the field by incorrect handling or usage.

Product must be returned via your authorized supplier for repair or replacement together with full information on any problem identified.

Full details on our warranty and product's returns policy can be obtained upon request.



ARGUS SECURITY S.R.L.
Via del Cannelo, 14
34015 Muggia (TS)
Italy

17

CO5110CPR
CO5110UK

EN 54-3:2001+A1:2002+A2:2006 Type B

EN 54-23:2010

CWS100-AV

For use in compatible fire detection and alarm system.

Category rating: W - 2.5 - 7

- Duration of operation: Pass
- Provision for external conductors: Pass
- Flammability of materials: Pass
- Enclosure protection: Pass
- Access: Pass
- Manufacturer's adjustments: Pass
- On-site adjustment of behaviour: Pass
- Requirements for software controlled devices: Pass
- Coverage volume: Pass
- Variation of light output: Pass
- Minimum and maximum light intensity: Pass
- Light colour: White
- Light temporal pattern / frequency of flashing: N/A / 0.5 Hz
- Marking and data: Pass
- Synchronization: Pass
- Durability: Pass
- Temperature resistance: Pass
- Humidity resistance: Pass
- Shock and vibration resistance: Pass
- Corrosion resistance: Pass
- Electrical stability: Pass